

Input Parameters

NOMINAL INPUT VOLTAGE RANGE	94.4 - 240VAC
MAX. INPUT VOLTAGE RANGE	85-264VAC
INPUT FREQUENCY	47-63Hz
MAXIMUM INPUT CURRENT	16 AMPS
INRUSH CURRENT	<50 AMPS

Output Parameters

Adjustment and Derating.

The Alpha 1500 series is designed to provide a max output power of 1500W at nominal output voltages. The following procedure must be used to ensure the PSU is operated within its ratings:

- a Calculate the user for power for each module (Volts x Amps).
- b Total power for slots 1-3 must be ≤858W. Total power for slots 4-7 must be ≤ 858W. Total power (slots 1-7) not exceeding value stipulated in unit limitations table
- c Calculate user ampere turns (Amps x turns) for each module.
- d Add total ampere turns: Slots 1-3 ≤120. Slots 4-7 ≤120. Total of slots 1-7 ≤ 200AT.

Modules	Note	Output Range (*13)	Current	Slots	Turns	Max Current Limit	Settings for hazardous energy
A	1	4.5-5.5V	60A	2	1	79.2A	>3V
AA	1	4.5-6.2V	60A	2	1	79.2A	>3V
AL	1	4.95-5.05V	60A	2	1	79.2A	>3V
B	2	4.5-5.5V	25A	1	1	33A	-
BB	2	4.5-6.5V	25A	1	1	33A	-
C	6	5-16V	16A	1	2	21.2A	>11.3V
CM	6	5.2-6.6V	16A	1	2	21.2A	-
CL	6	4.75-5.3V	16A	1	2	21.2A	-
CH	6,8	11.9-12.7V	16A	1	2	21.2A	>11.3V
D	6	18-29V	8A	1	4	10.6A	>22.6V
E		5-16V	8A	1	2	10.6A	-
		5-16V	8A		2	10.6A	-
EB		4.5-5.5V	9A	1	1	11.9V	-
		4.5-5.5V	9A		1	11.9V	-
EH		11.9-12.7V	8A	1	2	10.6A	-
		11.9-12.7V	8A		2	10.6A	-
EL		5.2-6.6V	8A	1	2	10.6A	-
		11.9-12.7V	8A		2	10.6A	-
EQ		4.5-5.5V	9A	1	1	11.9A	-
		2.7-3.9V	9A		1	11.9A	-
F	6	9-16V	33A	2	2	43.6A	>5.5V
FF	6	10-13V	33.5A	2	2	34.5A	>6.9V
GG	6	17.5-29V	24.5A	2	4	25A	>9.6V
G	6	17.5-29V	25A	2	4	33A	>7.2V
H	5	18-32V	5A	1	4	6.6A	-
		18-32V	5A		4	6.6A	-
J	4,6,7	30-48V	10A	2	4(16)	13A	>18.4
K	6	18-29V	15A	2	4	19.8A	>12V
L	2,6	1.8-3.2V	25A	1	1	33A	-
M	6	5-16V	8A	1	2	10.6A	-
N	5,6	18-32V	5A	1	4	6.6A	-

Modules	Note	Output Range	Current	Slots	Turns	Max current limit	Settings for hazardous energy
P		18-29V	5A	1	4	6.6A	-
		5-16V	8A		2	10.6A	-
PL		23.6-24.5V	5A	1	4	6.6A	-
		4.75-5.3V	8A		2	10.6A	-
Q	2,6	2.7-3.9V	25A	1	1	33A	-
R	1,6	2.7-3.9V	60A	2	1	79.2A	>3V
S	3,6	2.5-5.7V	85A	2	1	110.5A	>2.2V
T	1,6	1.8-3.2V	60A	2	1	79.2A	>3V
U	6	10-21V	16A	1	3	21.2A	>11.3
UU	6	10-21V	15.5A	1	3	16A	>15V
W		4.5-5.5V	15A	1	1	19.8A	-
Z	2	4.5-5.5V	25A	1	1	33A	-

Module Limitations

- 1 For A, AA, AL, R and T modules in slots 7 & 8, max output current is 51A .
- 2 For B, BB, Q, L and Z modules in slot 8, max output current is 20A .
- 3 For S modules in slots 1 & 2, max output current is 73A, in slots 2 and 3 max output current is 68A, in slots 3 & 4 max output current is 66A, in slots 4 & 5 max output current is 85A, in slots 5 & 6 max output current is 80A, in slots 6 & 7 max output current is 66A and in slots 7 & 8 max output current is 65A.
- 4 For J modules the output current derates linearly by 0.25A per volt above 40V.
- 5 For H and N modules with output > 29V, max output current is 1A.
- 6 When using remote sense, the max output voltage will be reduced by 0.5V for L, S, T, Q and R modules, and by 1.0V for C, CH, CL, CM, D, F, FF, GG, J, M, K, N, U, UU Modules.
- 7 Ampere turns for J module is calculated as AT=(output current + 15A) x 4.
- 8 For C and CH modules, the maximum output current is 12A for output voltages >12V.
- 9. Adjusting output voltage beyond the stated range may cause overvoltage protection (OVP) to operate, whereby all outputs will turn off. To reset OVP, turn back output voltage adjustment and remove the mains supply for 30 seconds

Unit Limitations

Input Voltage	Intermittent Output Power Rating	Continuous Output Power Rating	Maximum Ambient Temp
90 - 100VAC	-	1000W	45DegC
100 - 264VAC	-	1000W	50DegC
150 - 165VAC	-	1500W	50DegC
165 - 180VAC	-	1595W	50DecC
180 - 264VAC	-	1690W	50DegC
85 - 264VAC	-	800W	50DegC
85 - 90VAC	1000W *	-	50DegC

* - 1000W for 30 seconds maximum followed by 800W for 60 seconds minimum.

For units with MFPP option, the input voltage range is limited to 180-264VAC only

Important safety Instructions

Servicing

These products are not customer serviceable. Repairs may only be carried out by Lambda UK or their authorised agents. These products are not authorised for use as critical components in nuclear control systems, life support systems or equipment for use in hazardous environments without the express written approval of the Managing Director of Coutant Lambda Ltd.

Energy Hazards and SELV

Certain modules are capable of providing hazardous energy (240VA) according to output voltage setting. Final equipment manufacturers must provide protection to service personnel against inadvertent contact with these module output terminals. If set such that hazardous energy can occur then the module terminals or connections must not be user accessible.

Approval Limitations: Use in North America (AC units only)

When this product is used on 180VAC-250VAC mains with no neutral, connect the two live wires to L (live) and N (neutral) terminals on the input connector. In this instance double pole fusing is required.

High Voltage Warning

Dangerous voltages present within the power supply. Do not remove covers.

External Hot Surfaces

Section 6 of the Health and Safety at Work Act requires that manufacturers have an obligation to protect service engineers as well as users. In order to comply with this, a label must be fitted to these products which is clearly visible to service personnel accessing the overall equipment, and which legibly warns that surfaces of these products may be hot and must not be touched when the products are in operation

Safety Earthing Screw

On products with an enclosure, special safety earthing screws are used which connect the cover to the chassis. They must not be removed.

Safety Class of Protection

These products are designed for the following parameters : Material Group IIIB, Pollution Degree 2, Overvoltage Category II, Class 1 (earthed), Indoor use as part of an overall equipment such that the product is accessible to service engineers only.

Safety approvals

UL60950-1 and CSA22.2 No 60950-1 - UL Recognised. C-UL for Canada.
IEC/EN60950-1 - CE mark. CE marking when applied to any Alpha product, indicates compliance with the Low Voltage Directive (2006/95/EC) in that it complies with EN60950-1

Symbols

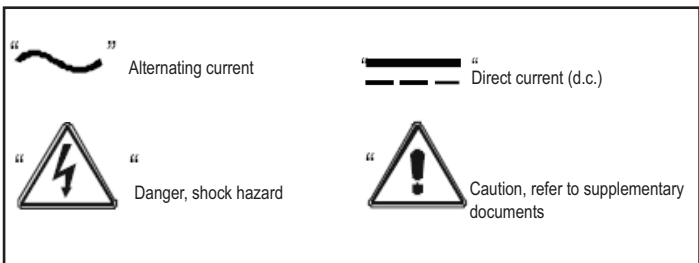

Input markings

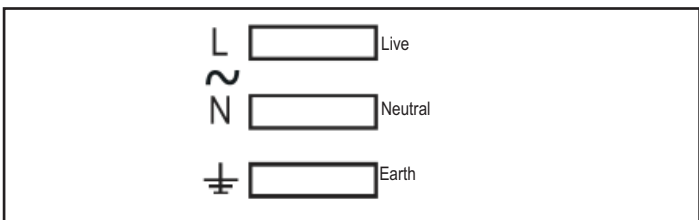

Environmental parameters

Operation
Temperature 0 to 50°C (derating 2.5%°C above 50°C to 65°C -Not covered by approvals).
Humidity 5 to 95% RH non-condensing. Air Pressure 70kPa to 106kPa.
Altitude -200m to 3000m

Storage and Transportation
Temperature -40°C to +85°C. Humidity 5% to 95% RH non-condensing.
Air Pressure 54kpa to 106kpa. Altitude -200m to 5000m.

Vibration and shock
10-200Hz @ 1.5G sinewave, 20G for 15 minutes in 3 axes random vibration / 3000 bumps, 10G (16mS) half sinewave.

Cooling
These units may be mounted in any of 4 orientations: Horizontal, on either side or vertical with airflow upwards. The airflow around the power supply air inlets and outlets must not be impeded when it is fitted in the end use application..

Level of insulation

Dielectric Strength testing is carried out as follows:
Primary mains circuit to earth - 2.25 - 2.35kVDC
Primary mains circuits to transformer core - 4.25 - 4.35kVDC*
Primary mains circuits to secondary -4.25 - 4.35kVDC.*
Outputs to each other and to earth are isolated to 500VDC.
*This test is not possible with modules fitted to the unit as damage to RFI capacitors will occur)

EMC performance

Emissions :
EN55022 Conducted RFI-Class A or B (depending on product - Consult Technical Sales).
Radiated RFI - Class A
EN61000-3-2 / A14 - Pass - Class A and D. EN61000-3-3 / A1 - Pass
Immunity:
EN61000-4-2 - Level 4 Criteria B EN61000-4-3 - Level 3 Criteria B
EN61000-4-4 - Level 4 Criteria B EN61000-4-5 - Level 3 Criteria B (Installation Class 3, Criteria B)
EN61000-4-6 - Level 3 Criteria B EN61000-4-11 - Pass VDE 0160 - Class 2 (Clause 7.3.1.1.)

General installation instructions

The Alpha family of component power supplies is designed for use within other equipment or enclosures which restrict access to authorised competent personnel only. For safe installation and operation of this product, carefully follow the instructions listed below:
i) The unit covers/chassis are designed to protect only skilled personnel from hazards and must not be made user accessible.
ii) These products are Class 1 and must therefore be reliably earthed and professionally installed in accordance with the prevailing electrical wiring regulations and the safety standards covered herein.
iii) These products are IPX0 and chemicals/solvents, cleaning agents and other liquids must not be used.

Mechanical parameters

DO NOT USE MOUNTING SCREWS WHICH PENETRATE THE UNIT BY MORE THAN 4.5 MM.
Weight 3 Kg dependent upon configuration.

Model	CA1500 7C_MF, 24K_D, 16U_D, 18/18H_D, 9/9E_D, 28/20H_D, 28/28H_D (NS-LAM-145)
Input voltage range	150-264Vac
Outputs	7V 16A, 24V 15A, 16V 16A, 18V 5A, 18V 5A, 9V 8A, 28V 5A, 20V 5A, 28V 5A, (1500W, 260AT total)
Ambient	50degC max
Orientations	All except psu vertical with airflow downwards and psu upside down.

Model	CA1500 8.5C, 36J_D, 12C_D, 24D_D, 18.5D_D, 18.5N_D, 30/18H_D (NS-LAM-136)
Input voltage range	150-264Vac
Outputs	9.5V 10A, 37V 8.5A, 13V 16A, 25V 9A, 19.5V 6.5A, 19.5V 3.7A, 31V 4A, 19V 2A (1203W, 235AT total)
Ambient	50degC max
Orientations	All except psu vertical with airflow downwards and psu upside down.

Model	CA1500 12FF_MF, 12FF, 12FF, 12FF (NS - AMD - 004)
Input voltage range	207-264Vac
Outputs	13V 34.5A max, 13V 34.5A max, 13V 34.5A max, 13V 26.5A max
Max Output Power	1690W, 260AT
Ambient	50degC max
Orientations	Horizontal Only

Model	CA1500 5BRP, 5SRP, 12FRP, 12FRP
Input voltage range	150-264Vac
Outputs	5.5V 25A max, 5.7V 85A max, 13V 33A max, 13V 33A max
Max Output Power	1480W, 242AT
Ambient	50degC max
Orientations	All except psu vertical with airflow downwards and psu upside down.

Model	CA1500 5A_MF, 3.3R, 2.5T, 24D, 12/12E (NS-LAM-212)
Input voltage range	90-264Vac
Outputs	5V 35A max, 3.3V 48A max, 2.5V 56A max, 24V 11A max, 12/12V 8/0.2A max
Max Output Power	836W
Ambient	50degC max
Orientations	All except psu vertical with airflow downwards and psu upside down.

Model	CA1500 5.1A_MF, 3.4R, 2.5T, 24.5D, 12.2/12.2E
Input voltage range	90-264Vac
Outputs	5.1V 35A max, 3.4V 48A max, 2.5V 56A max, 24.5V 11A max, 12.2/12.2V 8/0.2A max
Max Output Power	852W
Ambient	50degC max
Orientations	All except psu vertical with airflow downwards and psu upside down.

Connection details

Input Connections

Mating input faston connectors				
Brand	Colour	Wire size (awg)	Part number	Current rating
Amp	Red	22 - 18	2-520407-2	15A
Amp	Blue	16 - 14	3-520408-2	15A

Input tabs - 6.3mm x 0.8mm, tin plated brass, rated 15A.
Internal fuse (FS101) 6.3 x 32mm, F20AH/250V.

Output Connections

Output Connector Ratings:

- 6.35mm fastons are rated at 15A.
- 9.5mm Faston terminals are rated at 32A (Tab thickness = 1.0mm, suitable Faston terminals are AMP 151667-2 or AMP 280223-2)
- M5 screw terminals are rated at 100A subject to the wire and wire connector used to connect them. Maximum recommended torque setting for M5 screws is 2.5 - 3.0Nm.

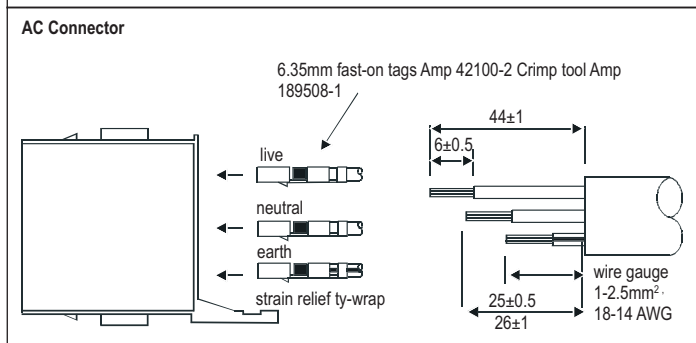
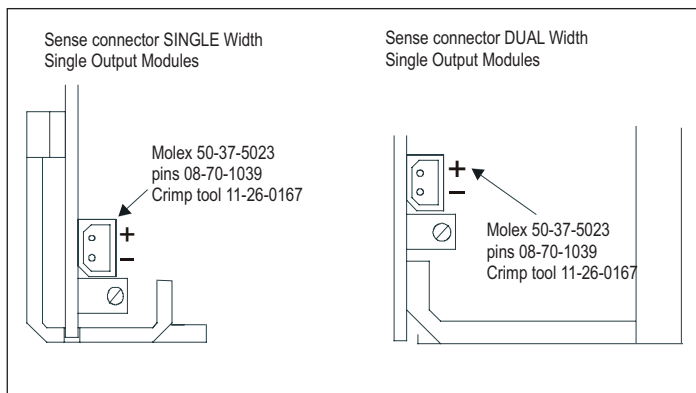

S1 connector for single output modules

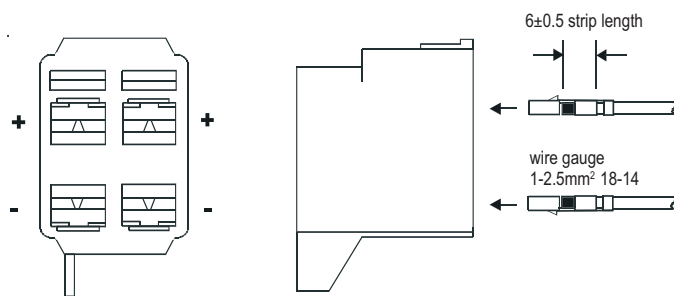

6.35mm fast-on tags Amp 42100-2 Crimp tool Amp 189508-1 max 25A per terminal, depending on wire.

S2 connector for single output modules

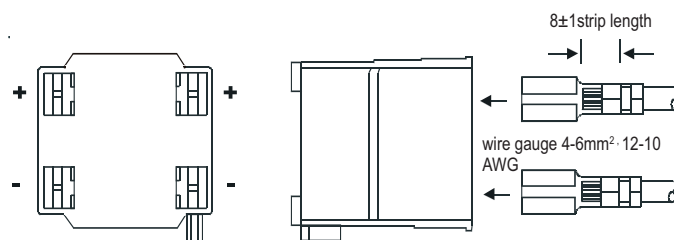

9.5mm fast-on tags Amp 151667-2 max 32A per terminal, depending on wire crimp tool Vogt 3975C

D1 connector for dual output modules

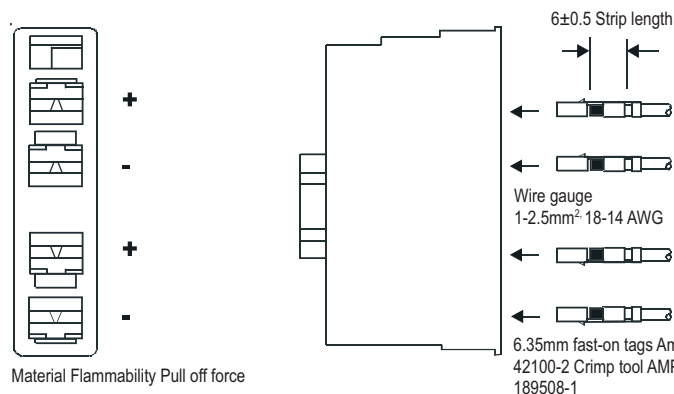

Material Flammability Pull off force
Rynite FR515
UL 94VO (temperature rating 140°C)
4 x 6.35 mm terminals, typically 5Kg
4 x 9.5mm terminals, typically 8Kg

Option: Mains fail options (MF, MFL, MFE, MFU, MFV)

Connector: Six way Molex, 50-37-5063. Crimp terminals: 08-70-1040.

	MF/MFL	MFE	MFU	MFV
Pin 1	Inhibit Low	Enable Low	Inhibit Low	Inhibit Low
Pin 2	+5V Aux	+5V Aux	+5V Aux	+5V Aux
Pin 3	Power Fail	Power Fail	Power Fail Emitter	AC Fail
Pin 4	0V Aux	0V Aux	0V Aux	0V Aux
Pin 5	Inhibit High	Enable High	Inhibit High	Inhibit High
Pin 6	NC	NC	Power Fail Collector	SYS Reset

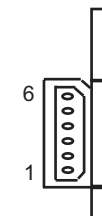

Option: PP - Parallel

Connector: Six way Molex, 90142-0006. Crimp terminals: 90119-2109.

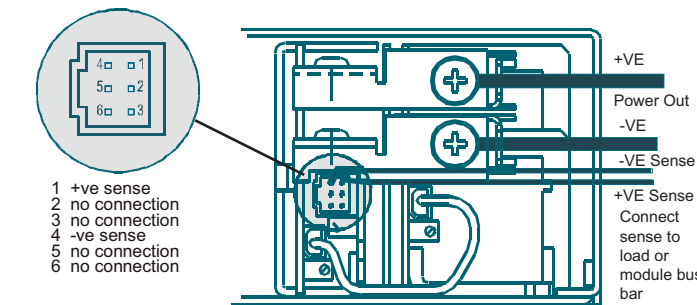

Option: PA - Parallel

Connector:
Six way Molex, 90142-0006.
Crimp terminals: 90119-2109.

Option: IN - Inhibit

Connector:
Six way Molex, 90142-0006.
Crimp terminals: 90119-2109.

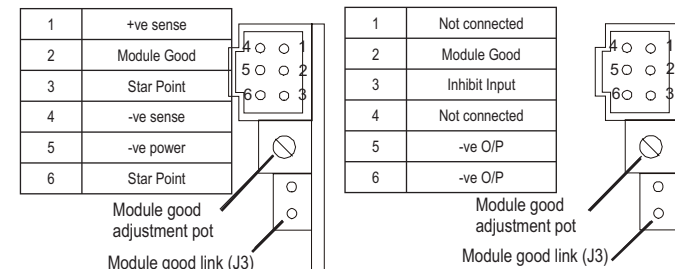

Option: RP - Remote Programming

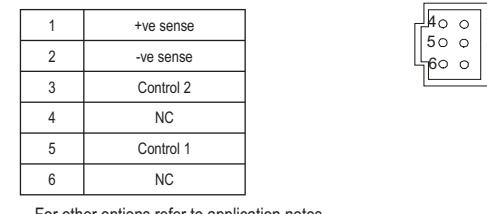

For other options refer to application notes

Customer fixings:

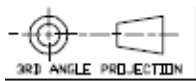

8 OFF M4 PRIMARY FIXINGS
4.5MM MAXIMUM SCREW PENETRATION

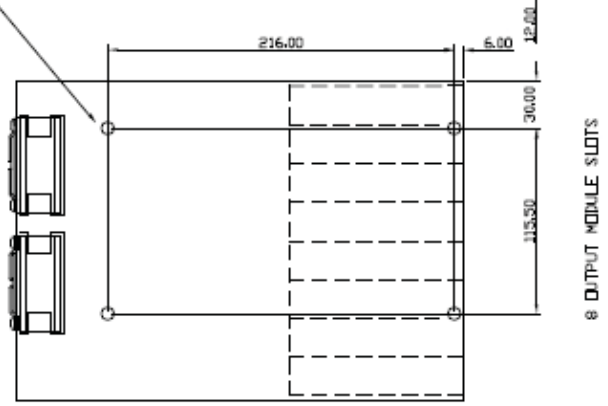
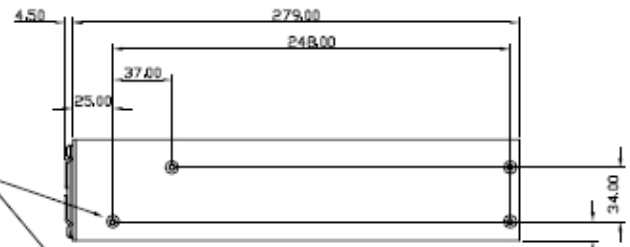
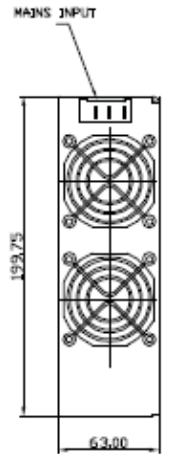

2 OFF M4 SECONDARY FIXINGS
4.5MM MAXIMUM SCREW PENETRATION
THESE 2 FIXINGS MUST ONLY TO BE USED IN CONJUNCTION WITH THE PRIMARY FIXINGS

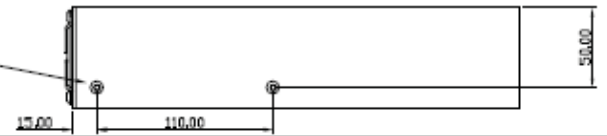

GENERAL TOLERANCE ± 0.5MM